

For Quick "Same Day Shipment" Order Early

Order Toll-Free 24 Hrs Call Free 1-800 Van Mark Fax Free 1-888 Van Mark





Save Time! Save Money!

All 300 Series Parts Numbers are Complete
"Ready to Use" Assemblies.

Ref	Description	Model	Model	Model
		TM8 Contr TM8HD Comm P/N	TM10 Contr TM10HD Comm P/N	TM12 Contr TM12HD Comm P/N
1	Cam Tube	4403	4404	4405
2	F-Bar w/SS / Tape Rule Contr	3136B	3138B	3140B
3	F-Bar w/SS / Tape Rule Comm	3137B	3139B	3141B
4	Front Hinge w/Green Vinyl Strip	3147B	3148B	3149B
5	Rear Hinge Contr	4511B	4513B	4515B
6	Rear Hinge Comm	4512B	4514B	4516B
7	Base Rail Contr	4437	4439	4441
8	Base Rail Comm	4438	4440	4442
9	*Strip, Stainless Steel 60 Series	4543	4544	4545
9	*Strip, Stainless Steel Power Lock™	4792	4793	4794
10	Hinge Pin	4062	4063	4064

*Can ship via UPS in 2 pcs.

Optional Accessories

TrimCutter™ 3017	Wheel Kit 3004	UniLeg™ UNL1	TrimFormer™ 3015
			
Cuts wide range of materials on all Mark Series Brakes	Fits all Van Mark Brakes Attaches to one end of Brake Base Rails	Provides stable footing on many Van Mark Tools	Add architectural depth to trim work

Parts For All Models

Ref	Part Name	P/N
11	Green Vinyl Wear Strips (2 ea)	3151
12	Tape Rule	4765
13	Handle w/Grip	3152
14	Handle Post	3153
15	Handle Faspins	3158
16	Lock Handle Bracket	3931
17	Carrying Handle	3154
18	Locking Cam	4801
19	Wedge Pads, UHMW	3155
20	Cam Tube Bearing	3901
21	Pivot Arm Spring	3902
22	Pivot Arm Casting	4462
23	Base Casting	4461
24	Material Stop Assembly (2 ea)	3965
25	Handle Grip	3156

Tune-Up Kits

Contractor Model P/N 3157
Commercial Model P/N 3159

Ref	Description
11	Strip, Green Vinyl Wear (2 ea)
19	Wedge Pads UHMW
21	Pivot Arm Spring
	Screws & Fasteners Package, Misc

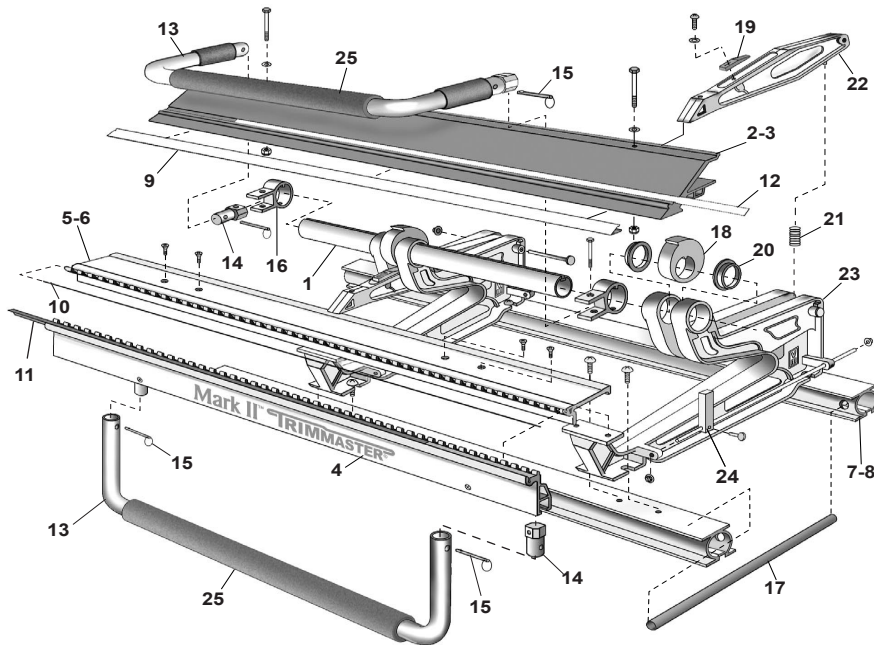

Ref no. 9

How to Identify Stainless Steel Edge

Stainless Steel Edge

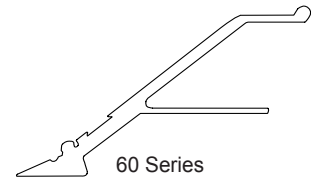
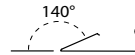

Stainless Steel Edge

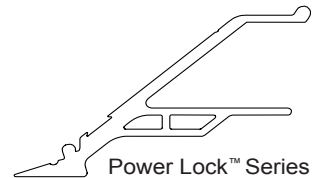
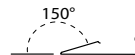

VAN MARK PRODUCTS CORPORATION

24145 Industrial Park Drive, Farmington Hills, MI 48335-2864 Michigan 1-248-478-1200

Call Free 1-800-VAN-MARK (1-800-826-6275) Fax Free! 1-888-VAN-MARK (1-888-826-6275)

Web Site: <http://www.van-mark.com>

E-mail: sales@van-mark.com

Note: Price subject to change without notice. Call for current prices before quoting.

Mark II TrimMaster®

Orders must include model and serial no in order to guarantee correct parts are shipped.

\$25.00 minimum order. F.O.B. Farmington Hills, MI.

Payable in U.S. funds only.